



Leica

MICROSYSTEMS

**Leica M125 C
Leica M165 C
Leica M205 C
Leica M205 A
User Manual**

General Instructions

Safety concept

Before using your microscope for the first time, please read the "Safety Concept" booklet included with your instrument. It contains additional information about handling and care.



Cleaning

- Do not use any unsuitable cleaning agents, chemicals or techniques for cleaning.
- Never use chemicals to clean colored surfaces or accessories with rubberized parts. This could damage the surfaces, and specimens could be contaminated by abraded particles.

Servicing

- Repairs may only be carried out by Leica Microsystems-trained service technicians. Only original Leica Microsystems spare parts may be used.

Responsibilities of person in charge of instrument

- Ensure that the Leica stereo microscope is operated, maintained and repaired by authorized and trained personnel only.

Safety Concept

The individual modules of the Leica M stereo microscopy series include an interactive CD-ROM with all relevant user manuals in 20 other languages. Keep it in a safe place, and readily accessible to the user. User manuals and updates are also available for you to download and print from our website at www.leica-microsystems.com.

This operating manual describes the special functions of the individual modules of the Leica M stereo microscopy series and contains important instructions for their operational safety, maintenance, and accessories.

The "Safety Concept" booklet contains additional safety information regarding the service work, requirements and the handling of stereo microscope, accessories and electrical accessories as well as general safety instructions.

You can combine individual system articles with articles from external suppliers (e.g. cold light sources, etc.). Please read the user manual and the safety requirements of the supplier.

Before installing, operating or using the instruments, read the user manuals listed above. In particular, please observe all safety instructions.

To maintain the unit in its original condition and to ensure safe operation, the user must follow the instructions and warnings contained in these user manuals.

Symbols Used



Read and understand user manual before using this device.

Warning of a danger



This symbol indicates especially important information that must be read and complied with. Failure to comply can cause the following:

- Hazards to personnel
- Functional disturbances or damaged instruments

Warning of hazardous electrical voltage



This symbol indicates especially important information that, if not observed, can cause the following:

- Hazards to personnel
- Functional disturbances or damaged instruments

Danger due to hot surface



This symbol warns against touching hot surfaces, e.g. those of light bulbs.

Important information



This symbol indicates additional information or explanations that intend to provide clarity.

Action

- This symbol refers to actions described in the text that are to be carried out.

Figures

- (1) Numbers in brackets within the descriptions relate to the figures and the items within those figures.

Safety Instructions

Description

The individual modules fulfill the highest requirements for observation and documentation of Leica stereo microscopes of the M series.

Intended use

- Refer to "Safety Concept" booklet

Non-intended use

- Refer to "Safety Concept" booklet

Never use M series microscopes or their components for surgical procedures (e.g. on the eye) unless they are specifically intended for that purpose.

The instruments and accessories described in this operating manual have been tested for safety and potential hazards. The responsible Leica affiliate must be consulted whenever the instrument is altered, modified or used in conjunction with non-Leica components that are outside of the scope of this manual.

Unauthorized alterations to the instrument or noncompliant use shall void all rights to any warranty claims.

Place of use

- Refer to "Safety Concept" booklet
- Electrical components must be placed at least 10 cm away from the wall and from flammable substances.
- Avoid large temperature fluctuations, direct sunlight and vibrations. These conditions can distort measurements* and micrographic images.
- In warm and warm-damp climatic zones, the individual components require special care in order to prevent the build-up of fungus.

* Measurement results depend on used objective, zoom and microscope settings.

Responsibilities of person in charge of instrument

- Refer to "Safety Concept" booklet

Ensure that:

- The M series stereo microscopes and accessories are operated, maintained and repaired by authorized and trained personnel only.
- All operators have read, understood and observe this User Manual, and particularly the safety instructions.

Safety Instructions (Continued)

Repairs, service work

- Refer to "Safety Concept" booklet
- Only original Leica Microsystems spare parts may be used.
- Before opening the instruments, switch off the power and unplug the power cable.



Touching the live circuit can cause injury.

Transport

- Use the original packaging for shipping or transporting the individual modules of the Leica M stereo microscopy series and the accessory components.
- In order to prevent damage from vibrations, disassemble all moving parts that (according to the user manual) can be assembled and disassembled by the customer and pack them separately.

Integration in third-party products

- Refer to "Safety Concept" booklet

Disposal

- Refer to "Safety Concept" booklet

Legal requirements

- Refer to "Safety Concept" booklet

EC Declaration of Conformity

- Refer to "Safety Concept" booklet

Health risks



Workplaces with stereo microscopes facilitate and improve the viewing task, but they also impose high demands on the eyes and holding muscles of the user. Depending on the duration of uninterrupted work, asthenopia and musculoskeletal problems may occur. For this reason, appropriate measures for reduction of the workload must be taken:

- Optimal arrangement of workplace, work assignments and work flow (changing tasks frequently).
- Thorough training of the personnel, giving consideration to ergonomic and organizational aspects.
- The ergonomic design and construction of the Leica M stereo microscopy series are intended to reduce the exertion of the user to a minimum.

Safety Instructions (Continued)



Direct contact with eyepieces is a potential transmission method for bacterial and viral infections of the eye.

The risk can be kept to a minimum by using personal eyepieces for each individual or detachable eyecups.



Warning of hand injuries

Technical safety

To connect the Leica M Series microscopes to power, use a power cable that meets the power cable specifications in your country. The power socket used has to be equipped with a 16 A or 10 A fuse. Only connect the instrument to a grounded power socket that has been installed according to regulations. The power supply voltage has to correspond to the voltage specified on the identification label.

Make sure that the ground connection is neither defective nor interrupted, since otherwise a malfunction poses a risk of fatal injury. Never unplug the power plug with moist or wet hands. There is danger of an electric shock.

Instrument safety and EMC

Our device has been designed, produced and tested in compliance with

- IEC EN 61010-1: Electrical equipment for measurement, control and laboratory use – Safety – Part one: general requirements
- EN 60950-1: Information technology equipment – Safety – Part one: general requirements
- Radio interference suppression in compliance with EN 55011 class B
- Noise immunity in compliance with DIN EN 61326-1.

The device meets the requirements of EU directives

- 2014/35/EU Low voltage directive
- 2014/30/EU EMC directive
- 2011/65/EU RoHS directive

and carries the CE mark.



The device must be disposed of in accordance with 2012/19/EU WEEE directive.

Intended for indoor use only in all EU member states, EFTA states and Switzerland.

Safety Instructions (Continued)

Handling electrical components



Never install any other plug (NEMA 5-15P) or unscrew any mechanical components unless expressly instructed to do so in the instructions.



The microscope must be connected to a grounded outlet.



Always position the microscope so that you can disconnect it from the power supply at any time. The power cable is provided as the power disconnect device.

Contents

General Instructions	2	Leica IsoPro Manual XY Stage: Assembly	31
Safety Concept	3	Cables: Connections	34
Symbols Used	4	Cables: Cable Duct	35
Safety Instructions	5	Cables: Diagram	36
Congratulations!	11	Leica LED5000 MCI	37
A Step Towards Infinity	12	Leica LED5000 MCI: Alternative Assembly	38
The Electronics: Comfort, Convenience and Safety for Your Experiments	13	Leica LED5000 RL: Assembly	39
The Modular Design: Everything is Relative	14	Leica LED5000 RL: Installing Optional Accessories	41
Maximum Compatibility	15	Leica LED5000 RL: Use	42
On We Go	16	Leica LED5000 NVI: Assembly on High-Performance Stereo Microscopes (Leica M125 C / Leica M165 C / Leica M205 C / Leica M205 A)	44
Assembly		Leica LED5000 NVI: Installing Optional Accessories	47
Base and Focusing Column	18	Quick Start Guide	
Assembling the Focusing Column for TL Bases	19	The Fastest Route to Success	50
Assembling the Focusing Column With an Incident-light Base	20	Overview of an M Series Microscope	51
Optics Carrier	21	The Correct Interpupillary Distance	52
Tube	22	Using the Eyepieces	53
Eyepieces	23	Focusing	54
Objective	24	Adjusting the Resistance of the Focus Drive	55
Objective Nosepiece – Assembly	25	Changing the Magnification (Zoom)	56
Objective Nosepiece – Adjusting Parfocality	26	Ratchet Steps and Magnification Levels	57
AX Carrier – Preparation	27	Parfocality: More Comfort and Convenience for Your Work	58
AX Carrier – Assembly	28	Iris Diaphragm	59
Transmitted-light Base Leica TL BFDF: Before First Use	29		
Transmitted-light Base Leica TL BFDF	30		

Contents (Continued)

Eyepieces	
Magnification Factors of the Eyepieces	61
Health Notes	62
Dioptric Correction	63
Dioptric Correction and Parfocality	64
Graticules	65

Photography & Video	
Photography & Video	67
Photo Tubes and C-mounts	68
Trinocular Video/Phototube 50 %	69
Trinocular Video/Phototube 100 %	70
Trinocular Video/Phototube 100 %: ErgoTube 5°– 45°	71

Microscope Carrier	
The Microscope Carrier AX	73
The Objective Nosepiece	75

Objectives and Optical Accessories	
The Different Types of Objectives	77

Bases	
Transmitted-light Base Leica TL BFDf: Controls	79
Transmitted-light Base Leica TL BFDf: Operation	80
Leica IsoPro (Non-motorized): Controls	81

System Illumination	
Leica LED5000 MCI	83
Leica LED5000 RL	85

Accessories	
Leica Hand Wheel and Foot Switch	87
Leica SmartTouch	88

Dimensional Drawings	
Leica M125 C / Leica M165 C	90
Leica LED5000 MCI	92
Leica LED5000 RL	93
Leica LED5000 NVI	94
Leica MATS TPX	95

Specifications	
Leica M125 C / Leica M165 C / Leica M205 C / Leica M205 A	97
Transmitted-light Base Leica TL BFDf	101
Motorized Focus Drives With "Zoom" Carrier (M125 C, M165 C, M205 C, M205 A)	102

Appendix	
Calculating the Total Magnification and Field of View Diameter	104
Care, Maintenance, Contact Persons	105

Congratulations!

Congratulations on obtaining your new Leica M series stereo microscope. We are convinced it will exceed your expectations, as never before have we applied our decades of experience in the areas of optics, mechanical engineering and ergonomics in such an uncompromising manner.

The M series embodies all the qualities you associate with the name Leica Microsystems: excellent objectives, high-quality engineering, and reliability. Furthermore, the modular design ensures that the M series adapts perfectly to your needs – no matter which accessories you require for your tasks.

Though the reliability and robustness of Leica stereo microscopes is legendary, like any high-tech product, the M series requires a certain degree of care and attention. Therefore, we recommend that you read this manual. It contains all the information you need regarding operation, safety and maintenance. Simply observing a few guidelines will ensure that even after years of intensive use, your stereo microscope will continue to work as smoothly and reliably as on the very first day.

We wish you the best of success in your work – after all, you are now equipped with the best tool!

A Step Towards Infinity

Ever since their introduction by Horatio S. Greenough, stereo microscopes have worked according to the optical principles based primarily on Ernst Abbe's research. For over a century, ingenious optics designers and engineers have worked to push magnification, resolution and image fidelity to the limit permitted by optics.

In doing so, they have always been constrained by the interrelation between three factors: the higher a microscope's resolution, the lower the available working distance. If one increases the distance of the optical axes, the three-dimensional image seen by the observer becomes distorted – a sphere becomes an ellipse, a flat surface curves toward the observer.

Limits are made to be broken.

The Leica M205 C is the world's first stereo microscope with a zoom range of 20.5:1. This accomplishment, however, was not enough for Leica's engineers. With the new FusionOptic in the M205 C, they have succeeded in going yet another step beyond previous limits. In addition to the increase in magnification, the resolution, too, has been increased to up to 1,050 lp/mm*, which corresponds to a resolved structure size of 472 nm.

Of course, this performance increase benefits your everyday work. Set up your specimens on the microscope with comfortable freedom of movement and discover details in stereo microscopy that you could never see before.

* Leica M205 C with 1.0× planapochromat and 10× eyepieces

The Electronics: Comfort, Convenience and Safety for Your Experiments

Never before have electronics been used as extensively in a Leica series as in the new M series. Optics carrier, tripod, base and illuminator are all connected using electrical contacts – which provides a number of advantages.



Contacts not only transmit data, but also supply the power.

Reliability for your experiments

Exact reproducibility of results is an increasingly common demand, particularly in research and development. The continuous encoding captures parameters such as the magnification, the illumination, the position of the iris

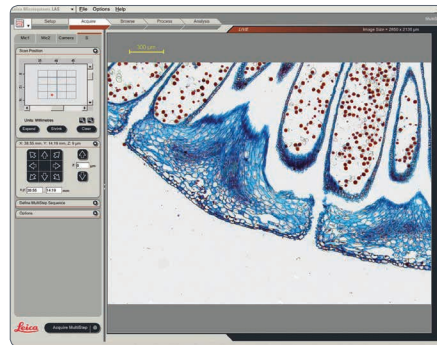

Leica Application Suite X (LAS X) evaluates the transmitted data and can restore the test situation later.

diaphragm and more to the Leica LAS X software. Thus you always know the conditions under which an image was acquired.

Fewer cables

A large part of the cables have been routed in the interior of the column. Data are also transferred via the interface between the column, the optics carrier and the carrier. The direct result is that you need fewer cables – this not only makes your workstation neater and more comfortable, it even makes it appear larger.

The Modular Design: Everything is Relative

The Leica M series provides maximum flexibility in choosing equipment, thanks primarily to the modular configuration and the compatibility that Leica has painstakingly maintained for decades. The optics carriers, eyepieces, bases and more can be combined in any way you choose, allowing you to create the microscope that best suits your needs.

Despite this, you will notice that the controls and individual components do not differ significantly. Whichever configuration you choose, you will quickly feel right at home.

Have a special request? Let us know!

Leica Microsystems enjoys an exceptional reputation when it comes to devising customer-specific solutions. If you have a special request that cannot be met with standard parts, contact your Leica consultant. We have a solution for every problem.

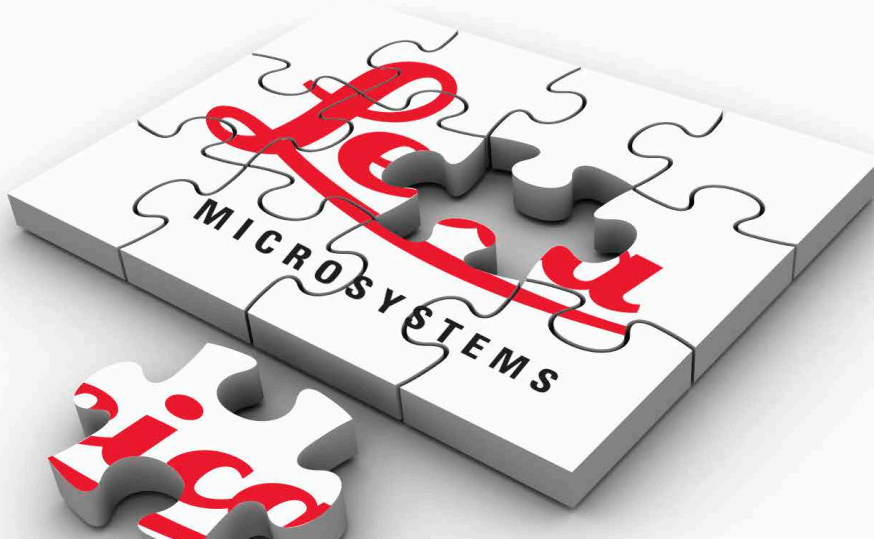

Maximum Compatibility

Leica engineers were careful to ensure that the new M series – like its predecessors – remains compatible with existing series. This means that objectives, bases, tubes and so on can be reused.

Objectives

All new objectives of the M series are parfocal, meaning that when used with the objective nosepiece, they can be replaced while keeping the specimen in perfect focus.

If you prefer, you can continue to use the previous objective series. In this case, parfocality is no longer guaranteed.

Tubes

The interface between the optics carrier and the tube has remained the same, so existing tubes fit the new M series. The new tubes are designed for eyepieces with field number 23, while the predecessor models were only designed for field number 21, resulting in a smaller object field.

Eyepieces

However, the new M-series eyepieces models have an audible and tangible click to provide immediate feedback in case of accidental adjustment.

On We Go

If your new Leica microscope has already been assembled and commissioned by your Leica consultant, click [here](#) to skip through the installation instructions and go directly to the Quick Start Guide on [page 49](#).



If, on the other hand, you are assembling the microscope yourself, continue with the "Assembly" chapter, which begins on [page 17](#).

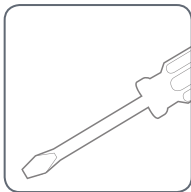

Assembly

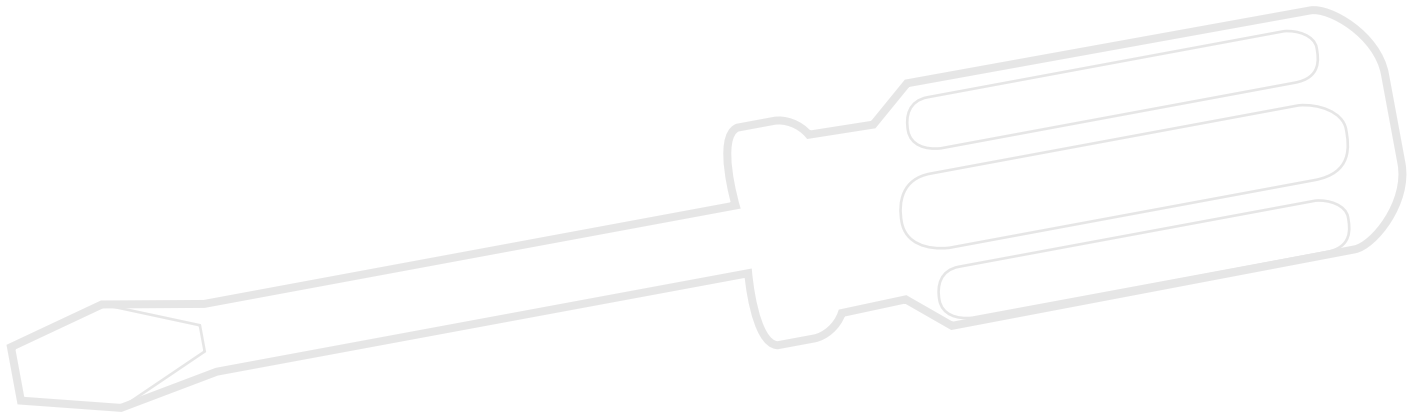

Base and Focusing Column

The first step is to connect the focusing column of the M Series to the corresponding base.

Tools used

- Hex socket screwdriver, 3 mm

Assembling the column adapter

1. Securely install the column adapter on the column using the four included screws.

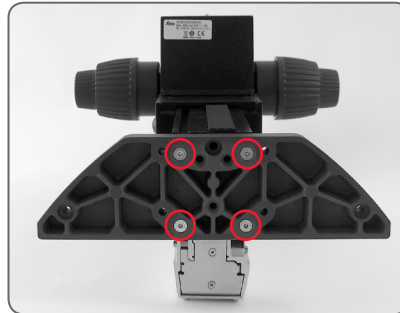

Assembling the focusing drive

2. Securely screw the focusing column to the base using the six included screws.

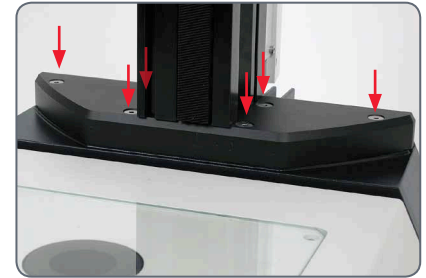

Assembling the Focusing Column for TL Bases

The first step is to connect the focusing column of the M Series to the corresponding base.

Tools used

- Hex socket screwdriver, 3 mm

Assembling the column adapter

1. Securely install the column adapter on the column using the four included screws.



Assembling the focusing column

2. Securely screw the focusing column to the base using the six included screws.



Assembling the Focusing Column With an Incident-light Base

When using an incident-light base, the focusing column and motorized focus are installed directly on the base; no extension plate is required.

Tools used

- Hex socket screwdriver, 3 mm

Assembly

1. Place the focusing column on the side.

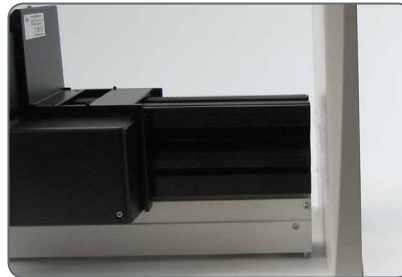

3. Screw the base securely onto the focusing drive.

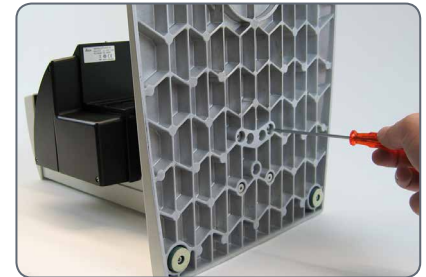

2. Insert the four screws provided into the outer holes of the base.

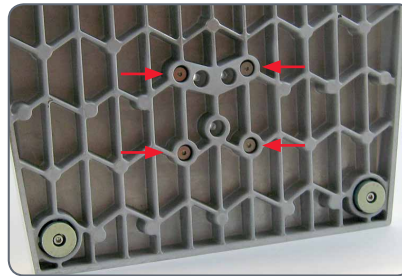

Optics Carrier

Tools used

- Hex socket screwdriver, 4 mm



Set the on/off switch to "0" to switch off the device.

Assembling the optics carrier

1. Place the optics carrier on the focusing column so that the screw fit into the thread provided and the lug fits into the groove.
2. Press the optics carrier backwards to the focusing column and screw it in place using your other hand.

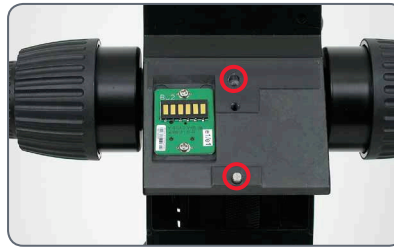

Tube

All intermediate tubes that fit between the optics carrier and the binocular tube are fitted in the same manner.

Tools used

- No tools required.

Preparations

1. Unscrew the positioning screw and remove the protective cover.

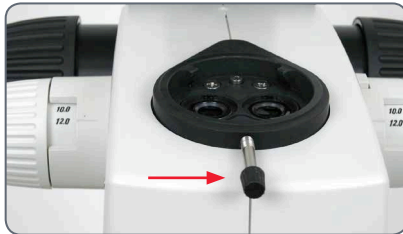

Assembling the tube

2. Push the tube (for example, the inclined binocular tube) into the dovetail ring and rotate it slightly in both directions until the positioning screw meshes with the guide groove.
3. While holding the tube only slightly, carefully tighten the positioning screw. It is automatically brought to the correct position.

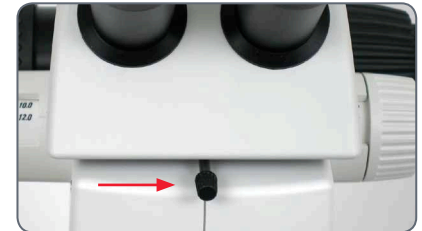

Eyepieces

Tools used

- No tools required.

Magnification range

You can extend the overall magnification range using available 10×, 16×, 25× and 40× wide-field eyepieces for persons wearing glasses.

Preparation

1. If you want to use an optional graticule, insert it now ([page 65](#)).
2. Remove the plastic tube guard.



Inserting the eyepieces

3. Push the eyepieces into the tubes as far as they will go and check to ensure that they fit tightly and accurately.



4. Securely tighten the clamping screws.



Objective

Tools used

- No tools required.

Preparation

1. Remove the protective cap on the optics carrier by turning it.



Attaching the objective



Hold the objective firmly during assembly and disassembly so that it does not fall onto the stage plate. This applies particularly to the 2× planapochromatic objective, which is very heavy. Remove all specimens from the stage plate first.

2. Screw the objective clockwise into the optics carrier.



Alternative fastening options

- If using the objective nosepiece, read the instructions on [page 25](#).
- If using the AX carrier, read the instructions on [page 27](#).

Objective Nosepiece – Assembly

Preparations



Hold the objectives firmly during assembly and disassembly so that they do not fall onto the stage plate.

- Move the drive housing all the way upwards and remove the optics carrier, if the carrier has already been installed.

Assembly

1. Remove the transport anchor from the objective nosepiece.



2. Rotate the moving part by 90° and attach the objective nosepiece to the drive housing from the front (!). Screw the objective nosepiece firmly into place.



3. Unscrew the three Phillips screws on the objective mount of the optics carrier and remove the intermediate ring.



4. Screw the optics carrier onto the objective nosepiece.
5. Screw both objectives onto the objective nosepiece. It makes no difference which position an objective occupies.
6. Unscrew the locking screws on both sides of the objective nosepiece.

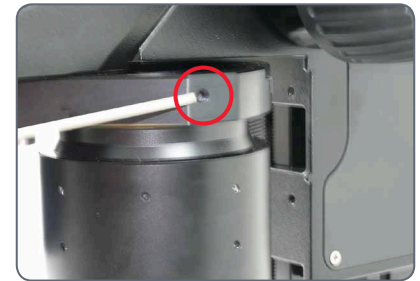

You can now adjust the parfocality (see instructions on the next page).

Objective Nosepiece – Adjusting Parfocality

The following procedure only has to be carried out once. Afterwards, both objectives are parfocal, meaning that the specimen remains in focus when the objective nosepiece is rotated.

This procedure must be repeated if you replace either of the two objectives with another.

The following example assumes the combination of the 1× and 2× planapochromats. If you are using another objective combination, replace the 2× objective in the description with the objective with the stronger magnification.

Preparation

- Open the iris diaphragm.
- Set the dioptic correction of the eyepieces to "0".

Adjustment

1. Rotate the 2× objective into the beam path and set it to the lowest magnification.
2. Focus on the specimen.
3. Rotate the 1× objective into the beam path.
4. Turn the objective on the thread in both directions until the specimen appears sharp.
5. Toggle to the 2× objective.
6. Select the strongest magnification and refocus until the specimen appears absolutely sharp.

7. Toggle to the 1× objective.
8. Turn the objective on the thread in both directions until the specimen appears absolutely sharp.

By means of zooming, check that the behavior of the objective is parfocal. Repeat the check with the other objective. If it is not parfocal, repeat the procedure.

9. Tighten the locking screws.



AX Carrier – Preparation

Tools

- Hex socket screwdriver, 2.5 mm

Preparing the AX carrier

Before the AX carrier is installed, it may first have to be prepared for the optics carrier to be used (Leica M125 C, M165 C, and M205 C / M205 A).

1. Check the switch position.



- If the switch position corresponds to the optics carrier used, skip the following steps. Otherwise, proceed as follows:

2. Unscrew the two screws that hold the switch in position.



3. Pull out the switch, rotate it into the desired position and reinsert it.

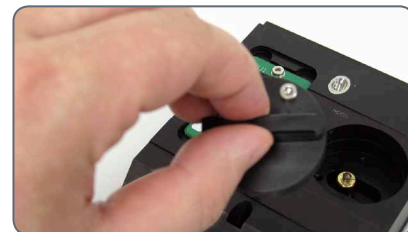

4. Important: push the switch all the way into the mount while reinserting the screws. Only this ensures that the switch is positioned correctly.



AX Carrier – Assembly

Tools

- Hex socket screwdriver, 4 mm
- Philips screwdriver

Once the AX carrier has prepared for the corresponding optics carrier, it can be installed.

1. Move the slide of the AX carrier into mid position.



Wrong



Right

2. Install the AX carrier on the focusing column.



3. Screw the objective to the AX carrier.



4. Unscrew the three holding screws and remove the adapter ring on the optics carrier.



5. Install the optics carrier on the AX carrier.

Transmitted-light Base Leica TL BFDf: Before First Use

Removing the transport anchors



Before you can use the transmitted-light base for the first time, it is absolutely necessary to remove the two transport anchors as follows.



Transmitted-light Base Leica TL BFDf

Standard delivery

The base is delivered with the adapter plate installed. The selected stage (XY stage or standard stage 10 450 562), and the focusing drive will have to be mounted later.

Stage assembly

The TL BFDf transmitted-light base can be equipped with different stages.

- Leica IsoPro manual XY stage
- Standard stage 10 450 562

The selected stage is mounted on the base before commissioning. You can switch between the stages at any time with just a few hand movements.

The following paragraph assumes use of the base without the stage mounted. Disassembly is performed in reverse order of the following steps.

Standard stage

1. Take the glass plate from the rectangular gap in the standard stage.
2. Position the stage on the transmitted-light base in such way that the four holes align over those in the base.
3. Attach the stage to the base using the four Allen screws provided.
4. Insert the glass plate back into the standard stage.

Leica IsoPro Manual XY Stage: Assembly

IsoPro XY stage

Before the IsoPro XY stage is mounted to the base, the axis containing the control buttons is attached either on the left or the right side of the XY stage.

If the controls are to be mounted on the left-hand side, the gear rod on the bottom side of the XY stage must be unscrewed and reattached in reverse.

1. Take the glass plate from the XY stage.
2. Turn the XY stage around and place it onto a non-slip surface.
3. Change the gear rod from the left to the right-hand side.
4. Skip the next two steps to mount the controls.

Before the IsoPro XY stage is mounted to the base, the axis containing the control buttons is attached either on the left or the right side of the XY stage.

Left or right operation

If the controls are to be mounted on the left-hand side, the gear rod on the bottom side of the XY stage must be unscrewed and reattached in reverse.

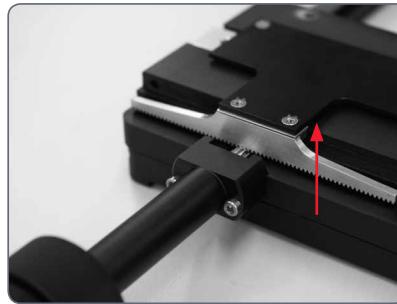

Leica IsoPro Manual XY Stage: Assembly (Continued)

1. Take the glass plate from the XY stage and turn it around.
2. Change the gear rod from the left to the right-hand side.

Control assembly

1. Take the glass plate from the XY stage and turn it around.
2. Attach the axis with the control buttons to the desired side. The fastener snaps into the XY stage magnetically.
4. Attach the axis with the two Allen screws provided.
5. Attach the cover rail to the XY stage.

XY stage assembly

1. Place the XY stage on the base.
2. Pull the upper part of the XY stage carefully toward the user, fastening the lower part onto the transmitted-light base.

Leica IsoPro Manual XY Stage: Assembly (Continued)

3. Screw the XY stage evenly onto the three threaded holes.
4. Push the XY stage all the way back towards the column.
5. Reinsert the glass plate back into the standard stage.

Focusing drive and column

1. Unscrew the extension plate from the base using the Allen key provided.
2. Attach your focusing drive column to the bottom using the three Allen screws.
3. Reattach the adapter plate to its original position using the three Allen screws.

Cables: Connections

The new Leica M series features extensive encoding with which various microscope data and settings can be read out, transferred to the PC and reproduced later.

- The interface to the optics carrier is on the column.



The terminals

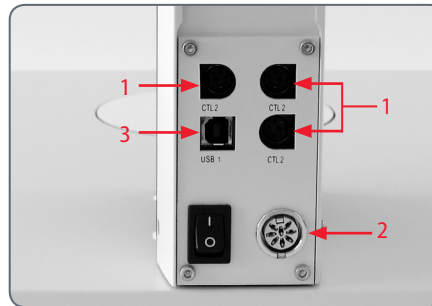

The connection to the PC and to other instruments is made using the terminals on the rear side of the column:

1. 3×CTL2 terminals for auxiliary equipment such as the ring illuminator, the base and other accessories from the Leica product range.
2. Terminal for the power supply provided.
3. USB terminal for the connection to the PC.

Cables: Cable Duct

The integrated cable duct in the column enables a neat cable layout around the microscope. For example, the USB or FireWire cables of the camera can be stowed in the cable duct.

Feeding the cables

1. Unscrew the three screws on the cable duct.

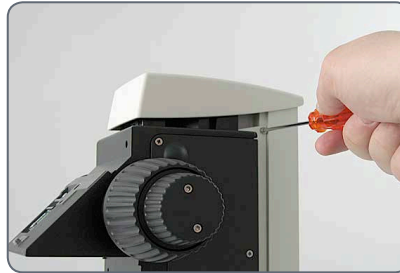

2. Remove the cover of the cable duct.

3. Place the cables in the cable duct and screw the cover on tightly.

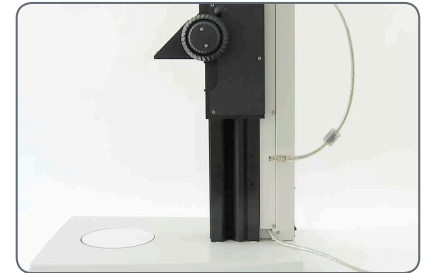

Tip: Estimate the length of the cable ends you will need before screwing on the cover. For thick cables, it is difficult to change the length retroactively.

Cables: Diagram

..... Alternative installation

Please use the Leica Application Suite X to configure the functions of the system.

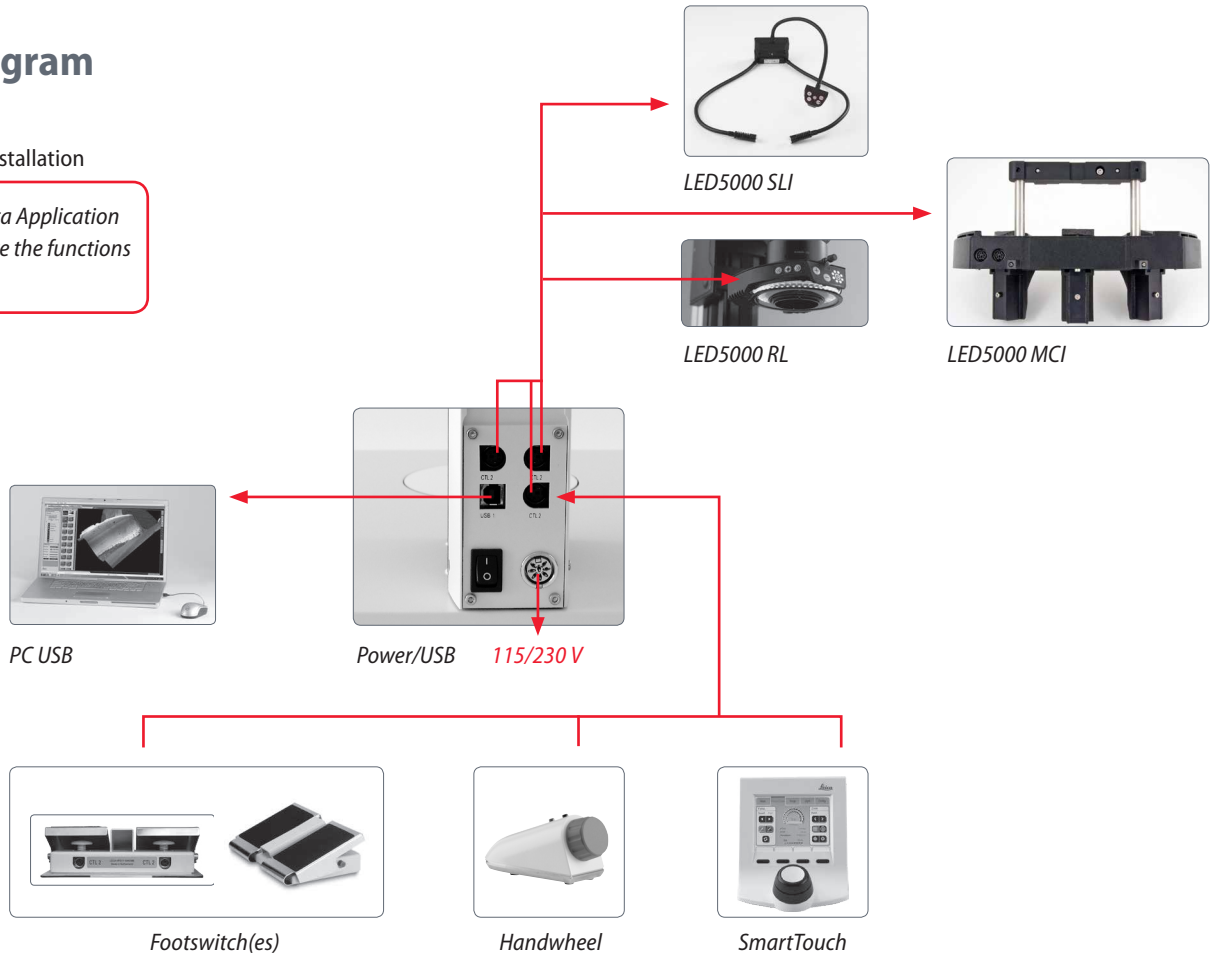

Leica LED5000 MCI

The Leica LED5000 MCI (for "Multi Contrast Illumination") is installed using two screws. For optimum accessibility, the optics carrier should be removed during installation (see [page 21.](#))



Constraints

The Leica LED5000 MCI cannot be used together with the objective nosepiece.

Assembly



1. Hold the LED5000 MCI with one hand and tightly screw the retraining stirrups on both top holes on the drive housing.

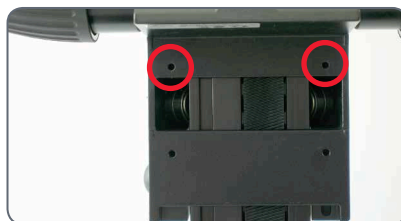

2. Connect the CAN-bus cable to either of the two sockets. (The flat part of the plug must be facing downwards.)



3. Plug the other end of the cable into one of the three "CTL2" sockets on the column.

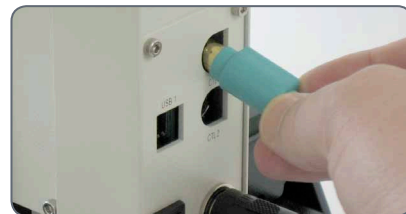

Leica LED5000 MCI: Alternative Assembly

Under certain circumstances, the light source must not be moved along with the optics carrier. A typical example is multifocus images in which the Z-stack changes while the angle of incidence of the light must remain the same. For such purposes, the Leica LED5000 MCI is directly fastened to the column.

Installation on the column

1. Pull the retaining stirrup out of the Leica LED5000 MCI.



2. Screw the retaining stirrup into the column at the notch using the single screw. If you tighten the screw, the retaining stirrup is automatically moved into the correct position.

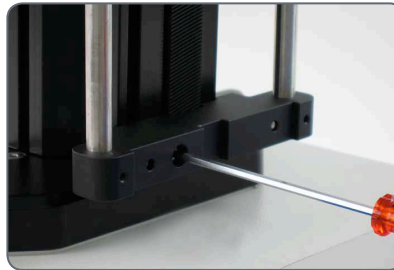

3. Push the Leica LED5000 MCI onto the retaining stirrup.

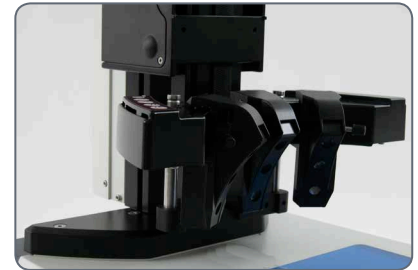

Leica LED5000 RL: Assembly

Required tools

- None

 The Leica LED5000 RL is installed on the objective using a single screw. It has been optimized for a working distance between 50 mm and 80 mm.

Constraints

The Leica LED5000 RL can be used only in conjunction with the planapochromat 1× and planapochromat 0.63× objectives. With all other objectives, the working distance is too low for adequate illumination.

The ring illuminator cannot be used together with the objective nosepiece.

Assembly

1. Connect the Leica CAN bus cable provided to the ring illuminator.



2. Place the Leica LED5000 RL against the objective from below, push it up as far as it will go and screw it into place.





3. Plug the other end of the cable into an available CTL2 socket on the column.



Continued on next page.

Leica LED5000 RL: Assembly (Continued)

 If you work with the manual focusing column without integrated electronics, the Leica LED5000 RL must be supplied with power via an external power supply unit (not included in the delivery package). Moreover, the illuminator cannot be controlled via Leica Application Suite X in this case.

 For optimum accessibility of the specimen, the ring illuminator should be installed with the cable facing backwards. However, it is also possible to turn the ring illuminator sideways, for example if simultaneously using the Leica LED5000 MCI system illuminator. In this case, the ring illuminator cannot be connected directly to the Leica LED5000 MCI.

Leica LED5000 RL: Installing Optional Accessories

Installing optional accessories

- You can screw the optional polarization set into place firmly using the metal plate provided.



- The optional polarization set (polarizer and analyzer) is attached and screwed in below the ring illuminator.



- The optional diffuser is attached and screwed in below the ring illuminator.



Leica LED5000 RL: Use



The light of the Leica LED5000 RL can be very bright. Therefore, always switch on the illuminator *before* you look through the eyepieces! Avoid looking directly into the LEDs.



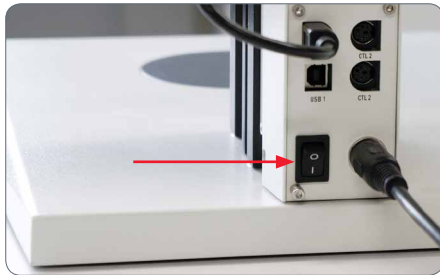

Switching on the focus column

1. Switch on the focus column using the power switch on the rear in order to supply the Leica LED5000 RL with current.







Using the front keypad









- Use the  key to switch the illuminator on or off.
- Use the  or  keys to adjust the brightness in 10 increments.
- Tap the  or  key briefly to adjust the intensity in small increments. Hold one of the keys to change the intensity more quickly.

Using the side keypad

- Use the  and  keys to toggle between the illuminator segments.
- Use the  key to toggle between the following illuminator segments: full ring, half ring (left–right), half ring (front–rear), quarter ring, opposite quarter rings, eighth ring.
- Use the  and  keys to rotate the active segments clockwise or counterclockwise.

Leica LED5000 RL: Use (Continued)

- If you press  or  for approx. 2 seconds, the segments rotate automatically until you press one of these keys again. If you change the segment using the  key, the automatic changeover is kept. Pressing  or  briefly stops the changeover.
- Press and hold the  key for approx. 2 seconds to switch on the full ring of the ring illuminator.



The active illuminator segments are indicated on the front control panel by 8 LEDs arranged around the on/off key.

Leica LED5000 NVI: Assembly on High-Performance Stereo Microscopes (Leica M125 C / Leica M165 C / Leica M205 C / Leica M205 A)

Assembly of the Leica LED5000 NVI (10 450 659)

1. The Leica LED5000 NVI in factory configuration is already assembled with the extension plate (for assembly on manual and motorized focusing columns) at the factory.



2. Place the Leica LED5000 NVI on the focusing column so that the screw fits into the thread provided and the lug fits into the groove.



3. Press the Leica LED5000 NVI backwards to the focusing column and screw it in place using an Allen key M4.



Leica LED5000 NVI: Assembly on High-Performance Stereo Microscopes (Leica M125 C / Leica M165 C / Leica M205 C / Leica M205 A) (Continued)

4. Unscrew the three Phillips screws on the objective mount of the optics carrier and remove the spacer ring.



5. Set the optics carrier on the adapter of the Leica LED5000 NVI and tighten it with an Allen key M4.

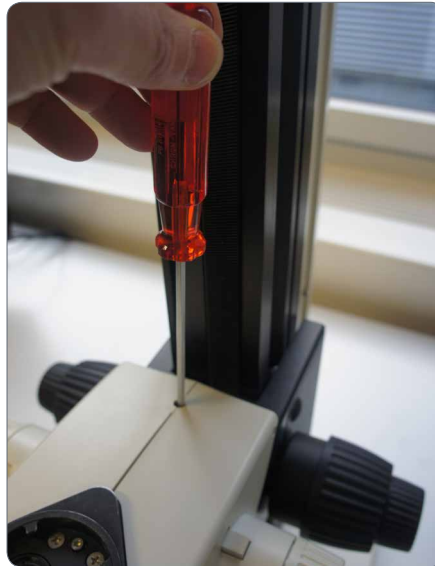

6. Install the remaining microscope components (tube, ergonomic accessories, camera etc.) according to the corresponding user manuals.

7. If the focusing column is equipped with integrated electronics, connect the Leica LED5000 NVI to the focusing column via the CTL2 connection. Alternative installation for manual columns: Connect the external power supply unit (10 450 266) to the Leica LED5000 NVI.



Leica LED5000 NVI: Assembly on High-Performance Stereo Microscopes (Leica M125 C / Leica M165 C / Leica M205 C / Leica M205 A) (Continued)

8. Screw the objective to the Leica LED5000 NVI from below.



Lists of recommended objectives that can be used with the Leica LED5000 NVI without additional adapters:

- 10 411 597 Achromatic objective f=100 mm
- 10 441 787 Achromatic objective f=150 mm
- 10 431 692 Achromatic objective f=175 mm
- 10 382 162 Achromatic objective f=200 mm
- 10 382 172 Achromatic objective f=400 mm
- 10 450 027 Planapochromatic objective 0.63×
- 10 450 028 Planapochromatic objective 1.0×
- 10 450 029 Planapochromatic objective 1.6×
- 10 450 030 Planapochromatic objective 2.0×

Additional objectives can be used by means of adapters. However, loss of optical quality does need to be expected (e.g. vignetting, color seams, reflections etc.).

Leica LED5000 NVI: Installing Optional Accessories

Polarization set

The Leica LED5000 NVI can be equipped with an optional polarization set. Using the polarization set, reflections can be reduced on metallic surfaces, for example.

1. The polarizer is inserted into the filter insert on the bottom of the Leica LED5000 NVI.



2. The analyzer is installed between the tube and optics carrier. To do so, remove the tube from the optics carrier. Place the analyzer on the optics carrier and then install the tube. Fasten the components by tightening the positioning screws.



3. To generate the desired polarization effect, rotate the rotary disk of the analyzer until the desired image quality is reached.

Leica LED5000 NVI: Installing Optional Accessories (Continued)

Filter inserts

The Leica LED5000 NVI is supplied with a filter holder as a standard feature. Commercially available filters of size 1/2" can be used. Make sure that the filters being used are sufficiently temperature-resistant, so they are not damaged by the high-energy illumination. Additional empty filter inserts (10 725 035) can be purchased as spare parts.

1. To disassemble the filter holder, push the filter holder approx. 1 cm to the side and remove the holder downwards out of the Leica LED5000 NVI. The filter holder is assembled in the reverse order of steps.



Quick Start Guide



The Fastest Route to Success

Your Leica stereo microscope has been delivered in completely assembled condition by your Leica partner, and naturally you want to get right to work. Therefore, your next step should be to study the Quick Start Guide, which outlines the most important steps at a glance.

This manual will then familiarize you with the finer details of your microscope. The following pages contain important, practical information that makes using it every day easier.

Take time to read it – it's worth it!

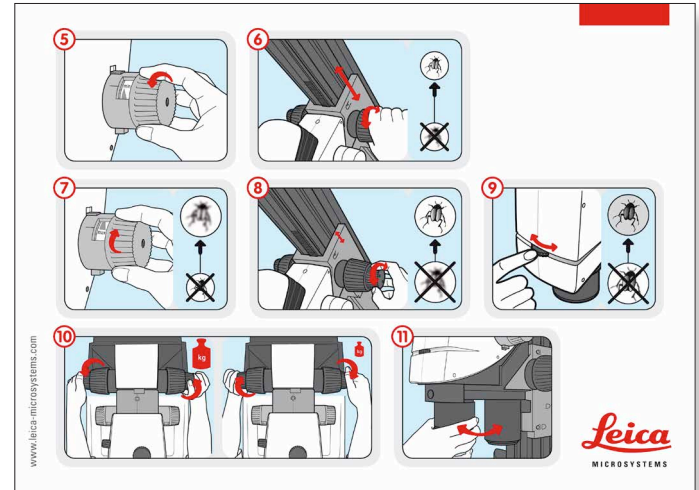

The M series quick start guide (included with instrument)

Overview of an M Series Microscope

1. Magnification changer (zoom)
2. Switch click stops on/off
3. Coarse/fine focusing
4. Fastening screw for the binocular tube (or accessories)
5. Interchangeable objective
6. Adjustable eyepiece tubes
7. Eyepieces for spectacle wearers with dioptic correction and eyecups
8. Fastening screws for the eyepieces
9. Trinocular tube
10. Built-in iris diaphragm

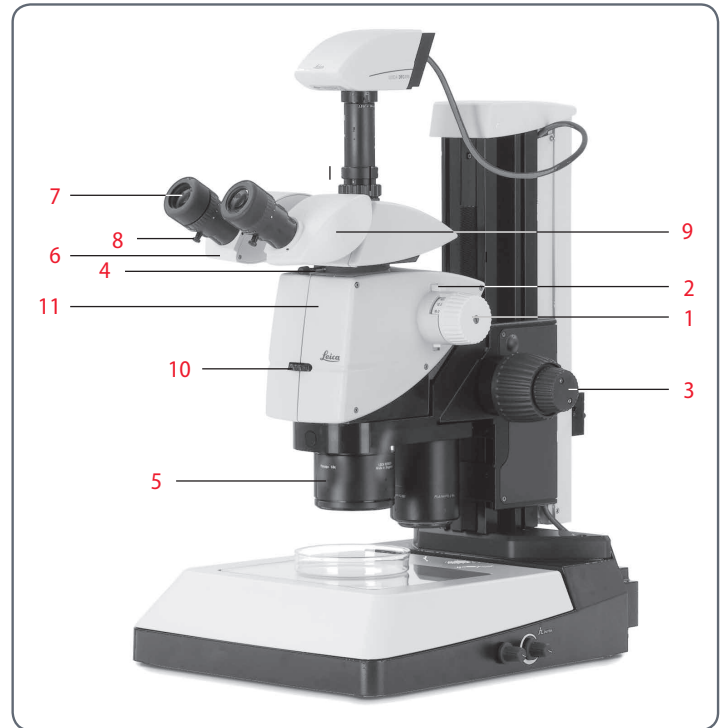

The Correct Interpupillary Distance

The interpupillary distance is correctly set if you see a single circular image field when looking at a specimen.

If you are still a novice microscope user, you may need a short time to become accustomed to this. Not to worry – after a little while, it will become automatic.

Reference value

The distance between eye and eyepiece measures approx. 22 mm for 10/23B wide-field eyepieces for persons wearing glasses.

Adjusting the interpupillary distance

1. Look into the eyepieces.
2. Hold the eyepieces with both hands. Push the eyepieces together or separate them until you see a circular image.

3. Slowly approach the eyepieces with your eyes until you can see the complete image field without corner cutting.



Using the Eyepieces

The eyepieces form the connection between the tube and the eye of the observer. Simply push them into the tube and they are ready to use.

Each eyepiece offers a certain magnification factor that has a determinative effect on the total magnification. Furthermore, all Leica eyepieces can be equipped with practical graticules that enable measuring and quantifying of specimens.

Dioptric correction

A built-in dioptric correction is available for eyeglass wearers. For more information, refer to [page 63](#).

If you do not wear glasses:

1. Hold the eyepiece firmly and rotate the eyecups forwards counterclockwise.
2. If an eyepiece is equipped with the integrated dioptric correction, turn the value to the "0" mark.



If you wear glasses:

1. Hold the eyepiece firmly and rotate the eyecups counterclockwise towards the rear, as otherwise the viewing distance is too great.



2. If an eyepiece is equipped with the integrated dioptric correction, turn the value to the "0" mark.

By the way, one benefit of viewing with eyeglasses is a drastically lower risk of bacterial transmission (see [page 62](#)). The soft material of the eyecup also ensures that your glasses will not be scratched, even if they contact the eyepiece.

Focusing

Focusing raises or lowers the stereo microscope using the focusing drive. The specimen detail is brought into sharp focus as soon as it is in the focal point of the objective.

- The focusing drive can be operated either left- or right-handed.

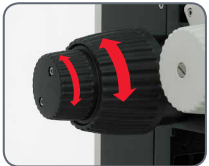

Focusing

- The inner, coarse adjustment is used for covering great distances.
- The outer, fine adjustment is used for fine focusing.

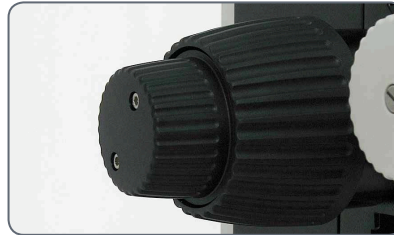

Coarse/fine adjustment

The sharpness is adjusted using the coarse/fine adjustment.

- The resolution of the coarse/fine adjustment is 1 μm .



The coarse/fine adjustment carries a load of up to 15 kg.

Adjusting the Resistance of the Focus Drive

Adjusting the resistance

Is the focus movement too loose or too tight? Does the outfit tend to slide downwards? The resistance can be adjusted individually depending on the equipment weight and personal preferences as follows:

1. Grip the outer drive knobs with both hands and turn them towards each other until the desired resistance is reached during focusing.



Changing the Magnification (Zoom)

All M series microscopes have an integrated zoom. The name indicates the zoom range covered:

- Leica M125 C = 12.5:1
- Leica M165 C = 16.5:1
- Leica M205 C = 20.5:1
- Leica M205 A = 20.5:1

The rotary knob for the zoom can be used either left or right-handed.

Zooming

1. Look into the eyepieces.
2. Focus on the specimen.
3. Rotate the magnification changer until the desired magnification is configured.



Ratchet Steps and Magnification Levels

The zoom button can optionally be operated either with or without ratchet steps. Continuous zoom is possible when the ratchet steps are disabled, which many users find convenient. On the other hand, when the ratchet steps are enabled, photographs, measurement results etc. can be reproduced more accurately.

Enabling and disabling ratchet steps

1. Push the top button downwards to disable the ratchet steps.
2. Push the bottom button upwards to enable the ratchet steps.



Magnifications and fields of view

The formula on [page 104](#) provide additional information about the magnifications and field of view diameters, with consideration given to the position of the magnification changer and the eyepiece and objective combination used.

Parfocality: More Comfort and Convenience for Your Work

All Leica stereo microscopes are parfocally matched, meaning that you can view a focused specimen from the lowest to the highest magnification without having to refocus. There is no need to readjust the focus to view of specimen location that is located higher or lower.

Requirements for parfocal work

- If you are using an eyepiece with dioptic correction, the procedure differs from this description. For more information, refer to [page 64](#).
- For the procedure for adjusting the parfocality for the objective nosepiece, refer to [page 26](#).

Parfocality

1. Enlarge the view to the maximum level.
2. Focus on the specimen.

You are done! Even if you select a smaller working distance, the specimen remains pin-sharp.

The parfocality is maintained until you focus on another level of the specimen.

Iris Diaphragm

The iris diaphragm in the optics carrier of your M series microscope has the same purpose as those in a camera shutter: it regulates the available light, which changes the depth of field. The "depth of field" is the area of a specimen that is brought into sharp focus.

Closing the iris diaphragm

- Close the iris diaphragm by turning the knob to the left. The subject appears darker and the depth of field increases.

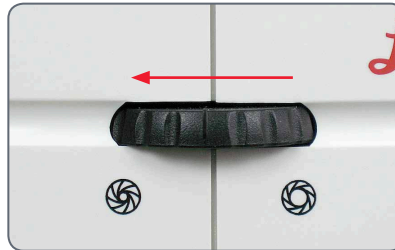

Opening the iris diaphragm

- Open the iris diaphragm by turning the knob to the right. The subject now appears brighter, but the depth of field decreases.

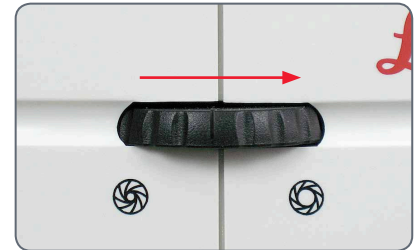

Eyepieces

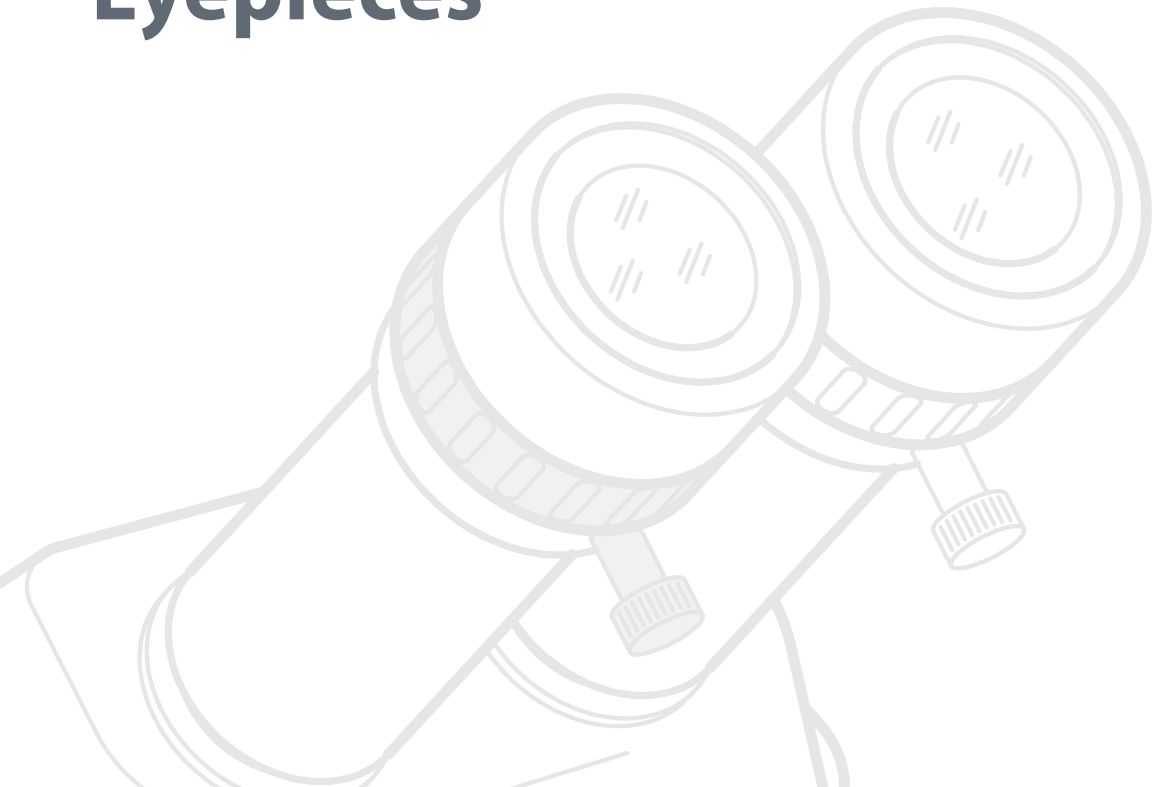

Magnification Factors of the Eyepieces

An eyepiece not only makes it possible to look passively into the microscope, but also has a critical effect on the maximum magnification. The magnification factor is between 10× and 40×.

The following eyepieces are available for the M series:

Magnification	Dioptric correction	Order number
10×	± 5 diopter settings	10 450 630
16×	± 5 diopter settings	10 450 631
25×	± 5 diopter settings	10 450 632
40×	± 5 diopter settings	10 450 633

Health Notes

Potential sources of infection



Direct contact with eyepieces is a potential transmission method for bacterial and viral infections of the eye. The risk can be kept to a minimum by using individual eyepieces or detachable eyecups. Eyecups can be ordered separately. Please contact your Leica partner.



Separate eyecups are an effective way of preventing infections.

Dioptric Correction

All Leica eyepieces are also available with built-in dioptric correction, allowing the microscope to be used without glasses even by those with vision problems. The correction comprises ± 5 diopter settings.



Using the dioptric correction

1. Set the dioptric correction of both eyepieces to the mid position ("0" diopter settings).
2. While wearing your glasses, look through the eyepieces and focus on the specimen.
3. Rotate both eyepieces to the maximum value of "+5".
4. Hold one eye closed and rotate the other eyepiece in "-" direction until the specimen appears sharp.
5. Then, open the other eye and correct the diopter settings until the image is uniformly sharp.

 Note that when using dioptric correction, the advantage of parfocality is lost – thus you have to manually refocus each time you change the zoom level. To also use parfocality with dioptric correction, refer to the instructions on [page 64](#).

Dioptric Correction and Parfocality

Leica stereo microscopes are parfocally matched. The prerequisite for this is the correct setting of the diopters and the parfocality. The following adjustments only have to be carried out once by each user.

Preparations

- Move the lever of the video/phototube to the "observation" position and open the diaphragm.
- If you are using the microscope carrier AX, set it to stereoscopic observation.

Adjusting

1. Set the dioptric correction for both eyepieces to "0".
2. Select the lowest magnification and focus on a flat specimen.
3. Select the highest magnification and readjust the sharpness.
4. Select the lowest magnification again, but do not look into the eyepieces.
6. Rotate the eyepieces counterclockwise in the "+" direction as far as they will go (+5 diopter settings).

7. Look into the eyepieces.
8. Slowly rotate each eyepiece individually in the "-" direction until each eye sees the object sharply imaged.
9. Select the highest magnification and refocus if necessary.

Now, if you adjust the magnification from the lowest to the highest level, the specimen is always brought into sharp focus. If not, repeat the process.

Graticules

Use

Graticules make length measurements and counting easier, particularly for workstations that are not equipped with a digital camera and LAS X software.

The graticules for length measurements and numbering are fitted in mounts and are inserted into the eyepieces.

1. Screw the insert off of the eyepiece.



2. Clamp the graticule on the insert, applying moderate pressure. Ensure that the graticule fits tightly.

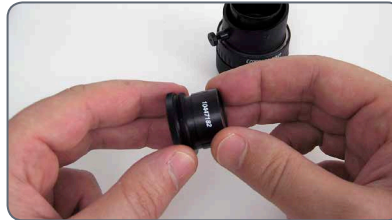

3. Screw the insert and graticule firmly into place and replace the eyepiece in the tube.



4. You can now align the graticule by rotating the eyepiece in the tube and then tightening it using the clamping screw.



Use with the AX carrier

 If possible, measure with the microscope carrier AX in vertical position. The measurements are more accurate without the convergence angle in the stereoscopic image.

Photography & Video

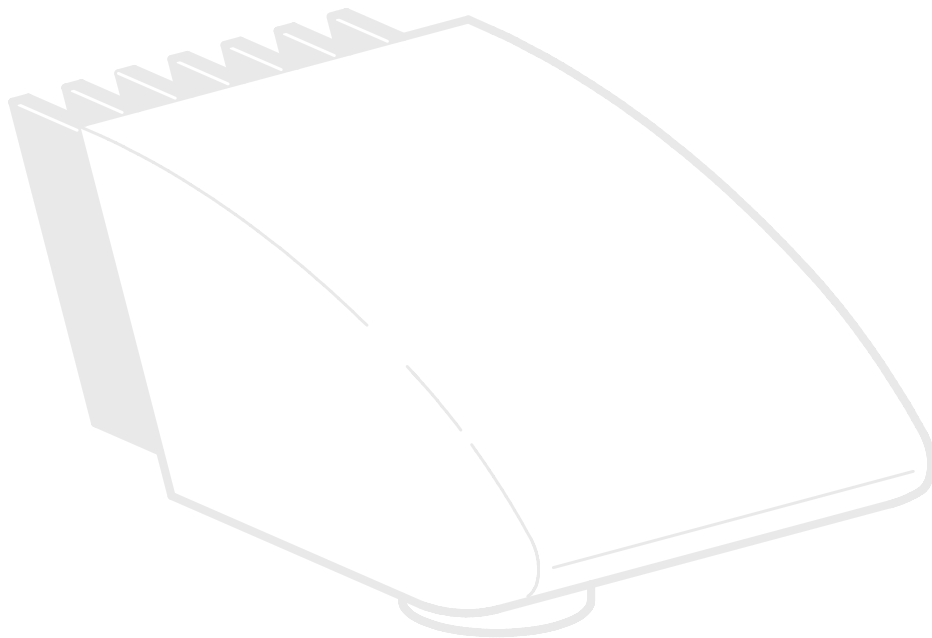

Photography & Video

For most microscope users, digital documentation has become an invaluable part of their work. Research results can be presented in an attractive manner; measurements on the digital image provide clarity and, in conjunction with scanning stages, even images of large specimens can be captured step by step and automatically joined to create a new complete image.

Adapter

If camera control using the Leica Application Suite X is not required, conventional mirror reflex and rangefinder cameras from third-party manufacturers can be used. For this purpose, Leica Microsystems offers a variety of adapters that can be used together with the 50 % and 100 % trinocular tubes.

Leica cameras

However, if you require absolute control over the camera and need the capability for measurement, evaluation and more in addition to photography, the digital Leica cameras are exactly right for you. Together with the Leica Application Suite X, they provide virtually limitless freedom of use. For additional information about Leica cameras, refer to the camera's documentation.



Leica Application Suite X

The "Leica Application Suite X", or "LAS X" for short, is, as it were, the digital extension of the Leica M series microscopes. In addition to capturing images, it lets you control the microscope, illuminator, stages, cameras and more. For additional information, refer to the LAS X online help.

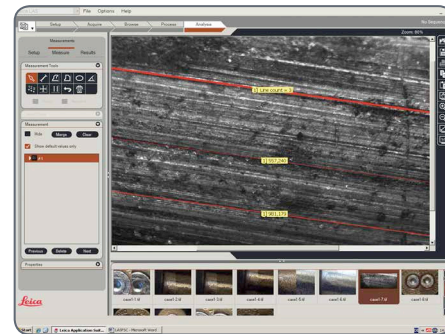

Photo Tubes and C-mounts

Application

All Leica DFC/DMC/MC cameras are equipped with a standardized C-mount interface. In turn, the C-mount adapter for the respective trinocular tube is connected to this interface. This adapter creates a solid mechanical connection between the microscope and camera and ensures optimum rendering of the microscopic image on the image sensor of the camera.

Usually, the ideal is for the digital camera to capture as much of the field of vision as possible, while excluding as much of the black edge of the field of vision as possible. To do so, the magnification factor of the C-mount adapter must match the image format of the sensor as closely as possible (see table).

If there is unwanted shading at the corners even with a compatible C-mount adapter installed, it can be corrected using the "Shading function" of the camera software.

Alternatively, you can also use a C-mount adapter with higher magnification. This primarily avoids the critical border area of the field of vision and concentrates on the center of the field of vision.

Cameras from third-party suppliers

In addition to Leica cameras with the standardized C-mount interfaces, you can connect third-party cameras to the microscope using a T2 bayonet adapter.

To do so, instead of the C-mount adapter, simply use the corresponding SLR adapter with T2 connection. However, these third-party cameras are not integrated into the Leica Application Suite X and have to be operated using the corresponding software from the camera manufacturer.

The Leica digital cameras are detailed in a separate user manual along with instructions for their assembly and use.

Photo tubes and C-mounts		
10 445 928	Video adapter 0.32×	C-mount interface for cameras with 1/3" sensors
10 450 528	Video adapter 0.5×	C-mount interface for cameras with 1/2" sensors
10 447 367	Video adapter 0.63×	C-mount interface for cameras with 2/3" sensors
10 446 307	Video adapter 0.8×	C-mount interface for cameras with 2/3" sensors
10 450 829	Video adapter 1.0×	C-mount interface for cameras with 1" sensors
10 450 317	Video adapter 1.0× HC	C-mount adapter for Leica HC C-mounts
10 445 930	Video adapter 1.0× delta	For Delta C-mount adapter with diameter 37 mm
10 447 436	DSLR adaption 1.6×	For APS-C format cameras
10 446 175	DSLR adaption 2.5×	Use in combination with 10 445 930 for 35 mm format cameras

Trinocular Video/Phototube 50 %

Use

With its third beam path, the trinocular video/phototube 50 % enables you to simultaneously view and photograph a specimen. The available light is divided as follows:

- 50 % is available for the two eyepieces.
- 50 % of the light is diverted to the video/photo beam path.



Assembly

Fasten the "trinocular tube 50 %" to the optics carrier instead of the binocular observation tube (refer to [page 22](#)).

Trinocular Video/Phototube 100 %

Use

With its third beam path, the trinocular video/phototube 100 % enables you to either view or photograph a specimen. This means that 100 % of the light is available to one or the other beam path. The other beam path remains opaque or black.

Assembly

Fasten the "trinocular tube 100 %" to the optics carrier instead of the binocular observation tube (refer to [page 22](#)).

Switchover

- Turn the controller on the right side of the tube into the horizontal position in order to guide all available light into the eyepieces. You can now observe the specimen.
- Turn the controller on the right side of the tube into the vertical position in order to guide all available light into the camera. You can now photograph the specimen.



Trinocular Video/Phototube 100 %: ErgoTube 5° – 45°

Use

The trinocular ErgoTube can provide the user a comfortable and ergonomic operating position by allowing the user to fine-tune the viewing angle of the eyepieces to best fit their posture.

The photo slider switches the right beam path from 100 % of light to the eyepieces to 100 % light to the camera port. In photo position the left beam path is closed to prevent stray light entering the tube.

Assembly

Before mounting the ErgoTube, please remove the transport lock screw under the tube. Otherwise the photo slider cannot be used.



Microscope Carrier



The Microscope Carrier AX

Users who intend to do a great deal of photography, take measurements or work with polarization should select the microscope carrier AX for stereoscopic/axial observation. The parallax-free imaging by means of a perpendicular beam path leads to results without parallax error.

Compatibility

The planachromatic and planapochromatic objectives fit into the thread in the microscope carrier AX for the Leica M125 C, Leica M165 C, Leica M205 C and Leica M205 A.

Stereoscopic viewing

A stereoscopic view is required for examining spatial objects. For this purpose, the microscope carrier AX must be brought to its home position.

1. Unscrew the clamping screw.



2. Push the microscope into the home position (mid position) to obtain a spatial view and tighten the clamping screw.

The Microscope Carrier AX (Continued)

Parallax-free images

The parallax-free imaging produces more precise results in photography, measuring and polarization.

1. Unscrew the clamping screw.
2. Push the microscope towards the left as far as it will go and tighten the clamping screw.



The objective is now located directly beneath either the left or the right beam path.

Coaxial light and the Leica M205 C / Leica M205 A

When using coaxial incident light together with the Leica M205 C / Leica M205 A, unscrew the clamping screw and press the optics carrier towards the right (caution: the movement is only 2 mm). This provides uniform light intensity in both beam paths.

The Objective Nosepiece

Use

The objective nosepiece enables you to switch between two objectives using just one hand movement, for example between a 1× and a 2× planapochromat.



Parfocal work

With the new M series objectives, the parfocality is maintained even when objectives are changed, meaning that the specimen remains in sharp focus during the change.



Older Leica objectives can continue to be used, but without parfocality during the objective change.

Technical constraints



The objective nosepiece cannot be used together with the LED5000 MCI system illumination, as the objective nosepiece can no longer be rotated.

Objectives and Optical Accessories



The Different Types of Objectives

To meet the various requirements regarding imaging properties, there is a choice of high-quality interchangeable planachromatic and planapochromatic objectives and also lower-priced interchangeable achromatic objectives.

- Achromatic objectives are particularly suited for specimens with high-contrast structures.
- Flat-field (planachromatic) objectives are particularly well suited for studying flat objects such as wafers and thin sections.
- With planapochromatic objectives, the finest structures are visible with high contrast. The sophisticated apochromatic correction allows these objectives to attain the highest color brilliance and fidelity.

Achromatic objectives

The 0.32×, 0.5×, 0.63×, 0.8×, 1×, 1.5×, 2× achromatic objectives offer countless variants for selecting the object field diameter, magnification ranges and working distances (see [page 104](#)).

Planachromatic objective 1×

For the highest requirements for overall image quality, we recommend equipping the microscope with the 1× plan (flat-field) objective, which returns sharp, contrast-rich object fields.

Achromatic objectives with a long focal length:

For special applications achromatic objectives with long working distances and focal lengths of $f=100$ mm to 400 mm are available.

Bases

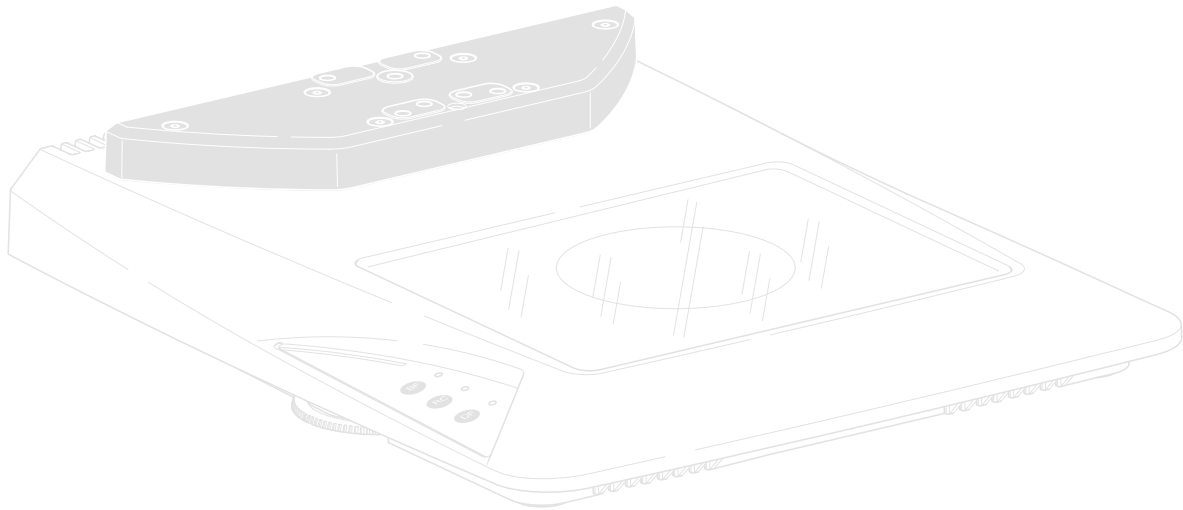

Transmitted-light Base Leica TL BFDf: Controls

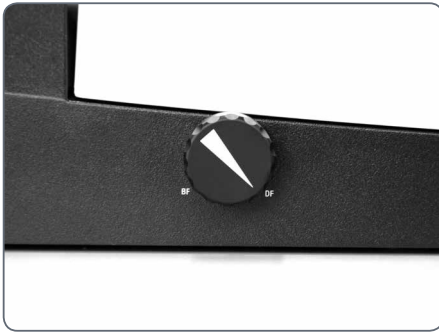

Button to toggle between bright field/dark field

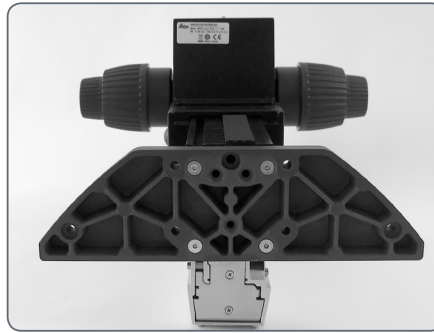

Extension plate of the transmitted-light base TL BFDf

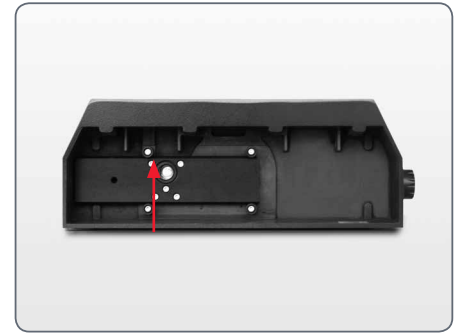

*Connector for cold light sources
(light conductor active $f = 10 \text{ mm}$,
end tube $f = 13 \text{ mm}$)*

Transmitted-light Base Leica TL BFDf: Operation

Light intensity control



Please observe the user manual – in particular, all safety regulations – from the manufacturers of the light guide and cold light source.

- Switch on the cold light source according to the manufacturer's user manual and adjust the brightness.

Transmitted-light control

The Leica TL BFDf transmitted-light base has a control that switches the light from "bright field" to "dark field".

Bright field

Bright field is suitable for examining translucent objects featuring contrasting structures. The object is directly illuminated from below and is seen in its natural colors against a bright background.

- Turn the control as far as it will go towards "BF" ("bright field").



Fingertip with bright field illumination

Dark field

In dark-field illumination, a ring illuminator is used in such a way that the direct light does not reach the objective without a specimen. Only the structure of semitransparent, opaque objects disperses the light, making the object visible against a dark background.

- Turn the control as far as it will go towards "DF" ("dark field").

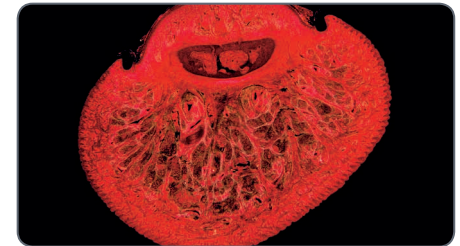

Identical subject with dark field illumination

Leica IsoPro (Non-motorized): Controls

Operating the XY stage IsoPro

1. To move the stage in X direction, rotate the outer knob.
2. To move the stage in Y direction, rotate the inner control ring.

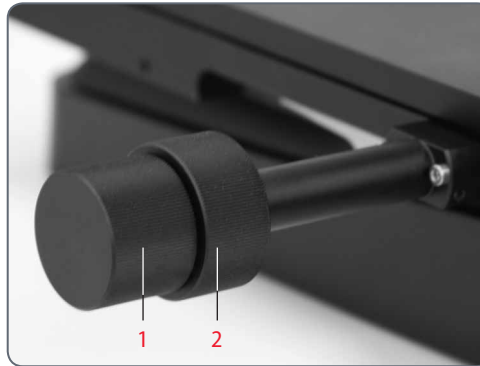

System Illumination

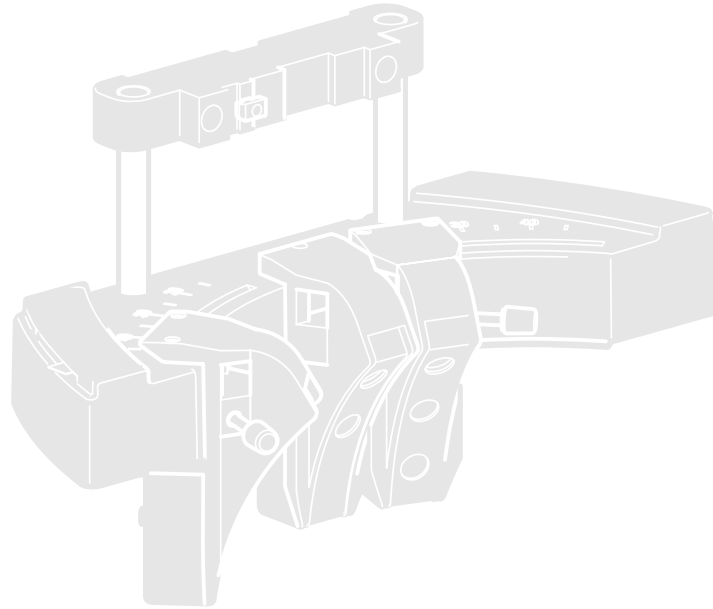

Leica LED5000 MCI

Use

The Leica LED5000 MCI (for "Multi Contrast Illumination") is a universal high-output illuminator. Three groups of 3 LEDs each can be arranged as desired around the specimen. The targeted control of the LEDs enables various illumination scenarios to be implemented.

Preparation

Hold the MCI with both hands and pull it downwards until the illuminator clicks into place on the bottom end of the guide rods.

In this position, you always have the same contrast with identical illumination. This guarantees the reproducibility of an experiment.

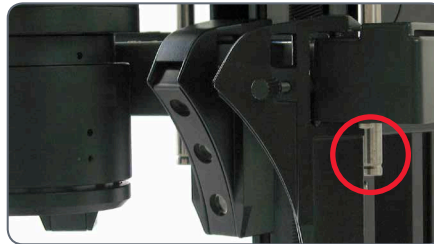

Installed too high

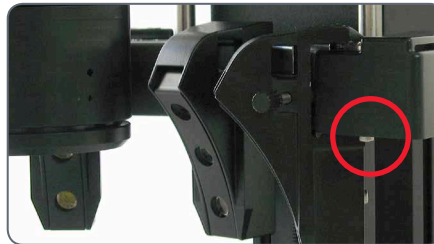

Optimum height

Contact with the base



If the optics carriers are accidentally lowered too far, contact between the base and MCI may result. A safety mechanism in the linkage ensures that, in this case, the MCI is automatically pushed upwards to prevent the possibility of damage.

- Be sure not to place any specimens directly beneath the MCI.
- After the optics carrier is lifted, put the MCI back into the original position.

Leica LED5000 MCI (Continued)

Using the keyboard

- Use the \odot key to switch the illumination on or off.
- Use the "+" and "-" keys to adjust the brightness in 10 increments. Touch either of the two buttons to adjust the intensity in small increments. Hold a key to change the intensity more quickly.

The illumination scenarios

Use the "<<" and ">>" keys to toggle between the illumination scenarios shown below.

Maximum brightness

For temperature reasons it is not possible to switch on all nine LEDs simultaneously. Therefore, to provide bright overall illumination, the top two rows are activated. The bottom row primarily provides contrast.

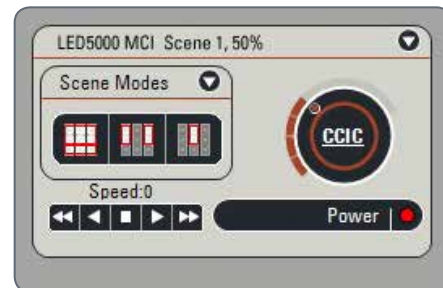

The Leica LED5000 MCI can also be controlled by the LAS X (Leica Application Suite X) software.

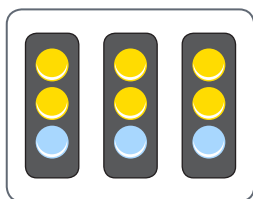

Maximum brightness

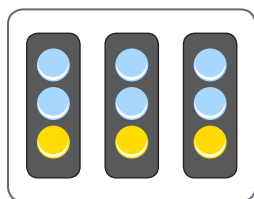

Maximum contrast

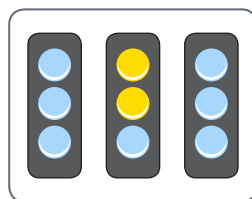

*Point illumination
from the rear*

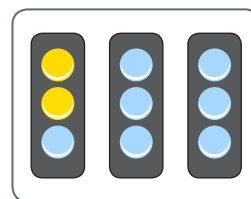

*Point illumination
from the left*

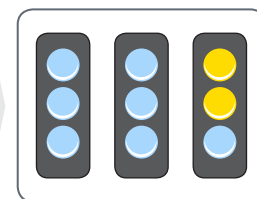

*Point illumination
from the right*

Leica LED5000 RL

Use

The Leica LED5000 RL ("Ring Light") generates a very bright and homogenous incident light. It has a diameter of 80 mm and illuminates the specimen with 48 LEDs that can be switched on and off completely or in various combinations. It is controlled using either the integrated or via the Leica Application Suite X (LAS X).

LAS X enables you to create fully reproducible illumination scenarios and automatically toggle between them. For additional information, refer to the LAS X online help.

Using the keyboard

- Use the \cup key to switch the illumination on or off.
- Use the "+" and "-" keys to adjust the brightness in 10 increments. Touch either of the two buttons to adjust the intensity in small increments. Hold a key to change the intensity more quickly.

The illumination scenarios

Use the "<<" and ">>" keys to toggle between the illumination scenarios shown below.

Constraint

The Leica LED5000 RL has been designed for use with the 1.0 \times and 0.63 \times objectives. For the 1.6 \times and 2.0 \times objectives, conventional ring illuminators from the Leica illuminator product range are available.

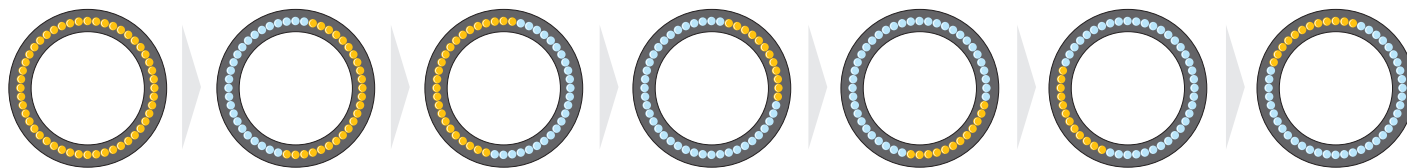

Accessories

Leica Hand Wheel and Foot Switch



Up to five foot switches can be configured with a microscope system. They can be programmed in LAS X to control focus, illumination, and individual memory positions.



The hand wheel is designed to control the motor focus.

Leica SmartTouch



With the touchscreen of the Leica SmartTouch, you can control your experiment procedures with a few hand movements and never lose sight of all your important optical parameters.

For a detailed description of the functions and settings, please refer to the Leica SmartTouch manual or the Leica Application Suite X help file.

The most important control functions on the control unit can be adjusted to your specific needs with freely programmable rotary knobs and function buttons.

Controls

The functions of the individual knobs and screen elements can be configured both directly on the Leica SmartTouch and using the Leica Application Suite X.

The standard configuration when shipped from the factory is as follows:

- Top part of the knob = zoom
- Upper part of the knob = focus

Dimensional Drawings

Leica M125 C / Leica M165 C

Leica M125 C / Leica M165 C with incident light base and new focusing column
(dimensions in mm)

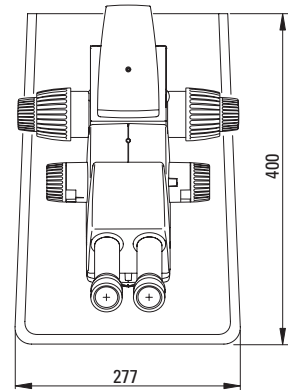
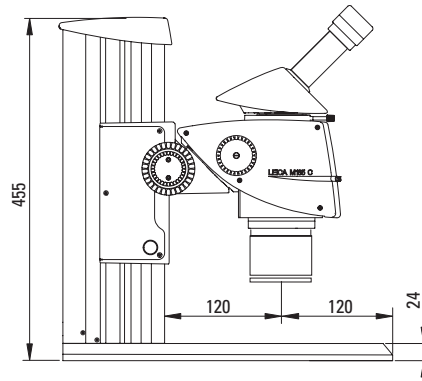
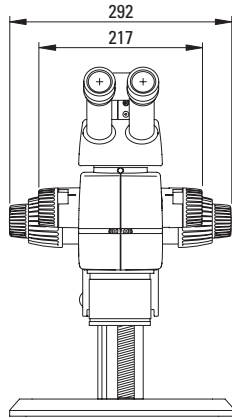

Leica M125 C / Leica M165 C (Continued)

Leica M125 C / Leica M165 C with transmitted-light base TL3000 Ergo and manual XY stage
(dimensions in mm)

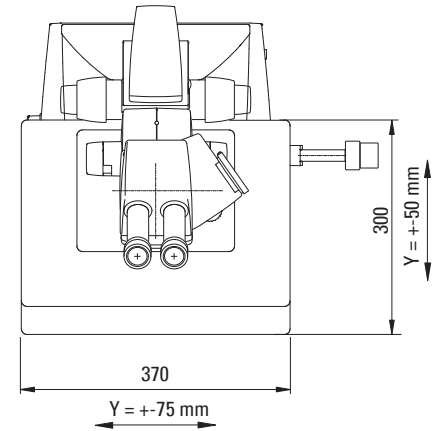
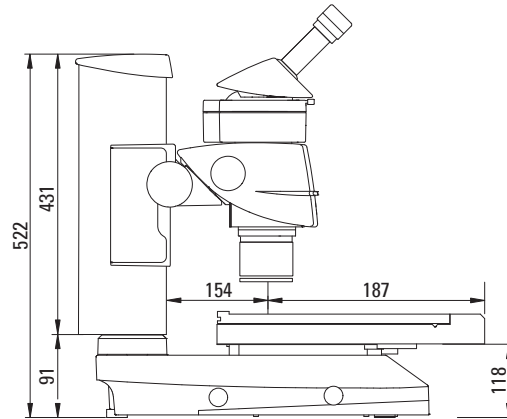
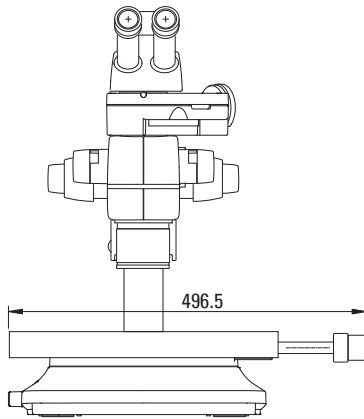

Leica LED5000 MCI

Leica LED5000 MCI
(dimensions in mm)

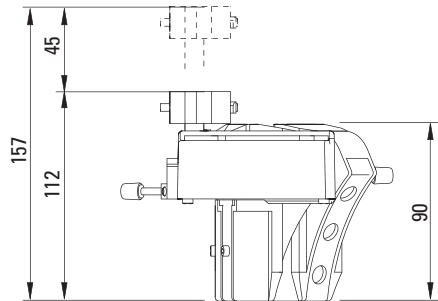
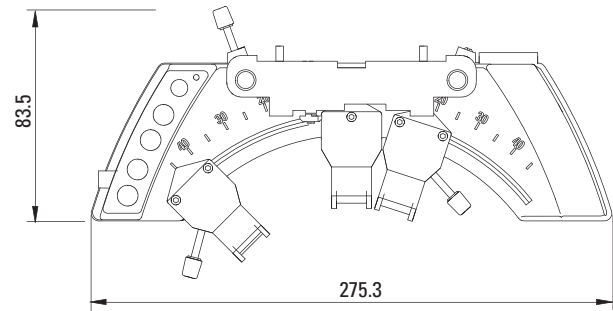
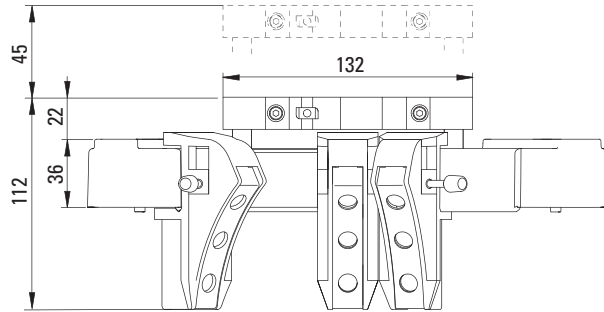

Leica LED5000 RL

Leica LED5000 RL
(dimensions in mm)

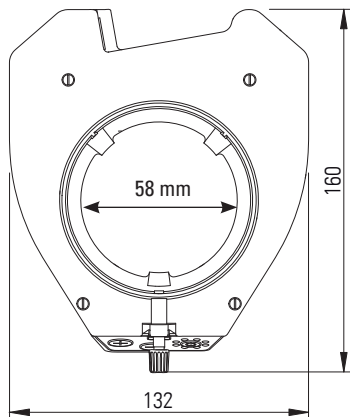
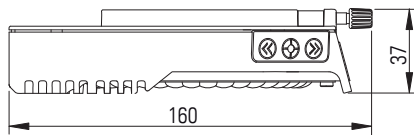
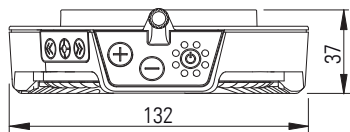

Leica LED5000 NVI

Leica LED5000 NVI for high-performance stereo microscopes
(dimensions in mm)

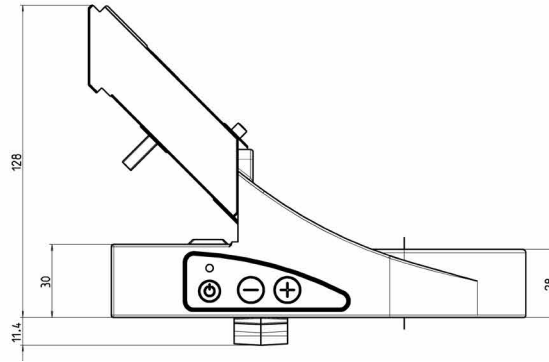
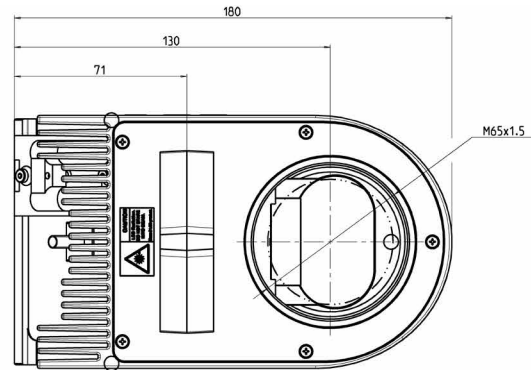
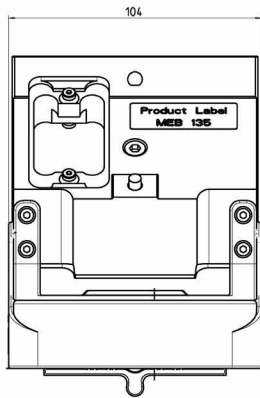

Leica MATS TPX

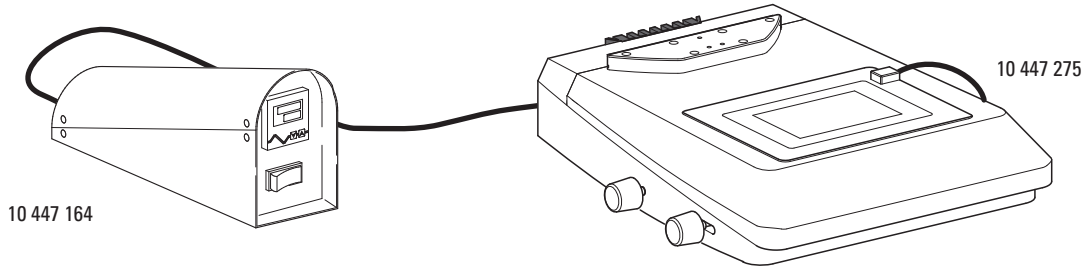
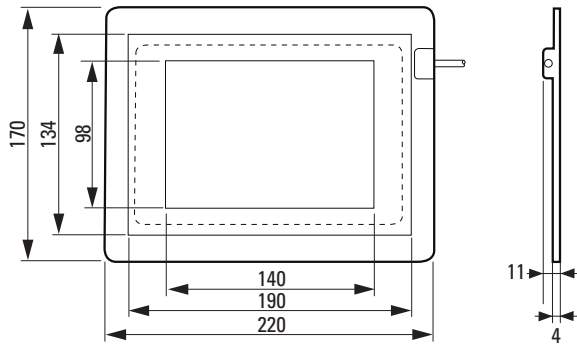

Specifications

Leica M125 C / Leica M165 C / Leica M205 C / Leica M205 A

	Leica M125 C	Leica M165 C	Leica M205 C / Leica M205 A
Optical data			
Zoom	12.5 : 1 manual	16.5 : 1 manual	20.5 : 1 manual/motorized with FusionOptics
Data with standard optics (1×objective/10× eyepieces) – Zoom range – Resolution – Working distance – Object field	8×–100× max. 432 lp/mm 61.5 mm (planapochromatic) Ø 28.8 mm – 2.3 mm	7.3×–120× max. 453 lp/mm 61.5 mm (planapochromatic) Ø 31.5 mm – 1.92 mm	7.8×–160× max. 525 lp/mm 61.5 mm (planapochromatic) Ø 29.5 mm – 1.44 mm
Maximum values (based on optics combination) – Magnification – Resolution – Visible structural width – Numerical aperture – Object field	800× 864 lp/mm 579 nm 0.288 Ø 68 mm	960× 906 lp/mm 551 nm 0.302 Ø 63 mm	1,280× 1,050 lp/mm 476 nm 0.35 Ø 59 mm
Working distances		135 mm (0.5× planachromatic) 112 mm (0.8× planachromatic) 67 mm (0.63× planapochromatic) 61.5 mm (1× planapochromatic) 30.5 mm (1.6× planapochromatic) 20.1 mm (2× planapochromatic)	

Leica M125 C / Leica M165 C / Leica M205 C / Leica M205 A (Continued)

	Leica M125 C	Leica M165 C	Leica M205 C / Leica M205 A
Optics carrier			
100 % apochromatic optical system	CMO (Common Main Objective) lead-free		
Specific surface resistivity (housing)	$2 \times 10^{11} \Omega/\text{mm}^2$ discharge time <2 seconds from 1,000 V to 100 V		
Coded/motorized function	Zoom, iris diaphragm, objective nosepiece (coded only)	Zoom, iris diaphragm, objective nosepiece (coded only)	Zoom, iris diaphragm, objective nosepiece (encoded and motorized)
Engageable zoom notches	12 for repetitive tasks	13 for repetitive tasks	14 for repetitive tasks (M205 C) Continuously variable control with SmartTouch or LAS X (M205 A)
Double-iris diaphragm for depth of field control	Built-in and encoded	Built-in and encoded	Installed and encoded (M205 C) / motorized (M205 A)

Leica M125 C / Leica M165 C / Leica M205 C / Leica M205 A (Continued)

	Leica M125 C	Leica M165 C	Leica M205 C / Leica M205 A
Accessories			
Standard objective (parfocal in the objective nosepiece)	1× planapochromatic		
Additional objectives (parfocal in the objective nosepiece)	2× planapochromatic, 1.6× planapochromatic, 0.63× planapochromatic		
Objective revolver, parfocal 0.63×–2× planapochromatic, coded	Fast magnification change 5.12× – 200×, parfocal	Fast magnification change 4.67× – 240×, parfocal	Fast magnification change 4.99× – 320×, parfocal
Binocular tubes, ergonomics	<ul style="list-style-type: none"> – Apochr. binocular and trinocular tubes with synchronized interpupillary distance adjustment – Various ErgoModules (optional) 		
Interpupillary distance	50 mm – 105 mm with the new trinocular ErgoTube®		
Wide-field eyepieces for eyeglass wearers	10×, 16×, 25×, 40×, with replaceable eyecups & click stop		
Manual coarse/fine focus	Focusing range 130 mm / 130 mm, adjustable ease of movement		
Microscope carrier AX for stereo or vertical observation	For convergence-free imaging without lateral shift of the specimen		
PC interface	USB		

Leica M125 C / Leica M165 C / Leica M205 C / Leica M205 A (Continued)

Modular System	Stands, illuminators
Transmitted-light base	TL4000 BFDf: Bright and circular dark field TL3000 Ergo: Bright field, dark field, Rottermann Contrast TL5000 Ergo: Bright field, two-sided dark field, Rottermann Contrast
Incident-light base	Large incident-light base with black-and-white stage insert and Antishock feet
Stages	Gliding stage, MATS heating stage, cup stage, rotatable polarization stage, Leica IsoPro XY stage (manual)
Illuminators	LED5000 RL, LED5000 SLI, LED5000 MCI, LED5000 HDI, LED5000 NVI, LED5000 CXI, cold light sources
	Misc. accessories
Photography, video	Digital image capture systems from Leica, various camera variants (e.g. integrated and external), various adapters for commercially available analog and digital cameras
Image archiving, image processing	Leica Application Suite X (LAS X) software, consisting of basic program and various auxiliary modules
Measurement reticules	For length measurements and counting
Vertical and oblique observation	45° side view around the complete object
Drawing tube	for left and right-handed users
Discussion tube for training for two observers	for two observers

Transmitted-light Base Leica TL BFDf

Light source	External via cold light source
Illuminated area	40 mm
Connections	Connection for cold light guide, active f=10 mm, end tube f=13 mm
Weight	5.8 kg
Illumination types	
Bright field	Yes
Dark field	Yes
Oblique light	No
Relief Contrast System (RC)	No
CCIC (Constant Color Intensity Control)	No
Internal shutter/lamp control	Yes*
Integrated filter holder	No
Coated optics for increasing the color temperature	No
Matching of high num. aperture	Yes**
Remote control options	Yes***
AntiShock Pads	Yes
Dimensions (W×H×D)	340×390×90 mm
*With cold light source Leica CLS150 LS **Plan mirror ***With external light source	

Motorized Focus Drives With "Zoom" Carrier (M125 C, M165 C, M205 C, M205 A)

	Technical data
Environment	
Operation temperature	10 °C – 40 °C
Storage temperature	-10 °C – 55 °C
Humidity (operating / storage)	10% – 90% RH (non condensing)
Operating altitude (maximum)	0 – 2,000 m
Storage altitude	nA
Pollution degree of intended environment	2 (office / lab environment)
Accessories	Various Leica controlling devices and Leica illumination devices
Ports and connectors	1 USB (2.0)
	3 CAN
	1 power (33 V)
Power supply	
Input	100 – 230 VAC ± 10 %, 50/60 Hz, 0.5 A – 1.2 A
Output	33 VDC, max 3.03 A (100 W)
Overvoltage category	II

Appendix

Calculating the Total Magnification and Field of View Diameter

Parameter

MO	Magnification of objective
ME	Magnification of eyepiece
z	Magnification changer position
q	Tube factor, e.g. 1.5× for coaxial incident light, 1.6× for 45° ErgoTube
r	Factor 1.25× if the planachromatic and planapochromatic objectives of the MZ125/MZ16 are used on the MS5, MZ6, MZ75 or MZ95
NFOV	Field number of the eyepiece. Field numbers are printed on the eyepieces: 10× = 21, 16× = 14, 25× = 9.5, 40× = 6.

Example

MO	1× objective
ME	25×/9.5 eyepiece
z	Zoom position 4
q	Coaxial reflected light 1.5×, tube factor
r	Factor 1.25×

Calculation example: magnification in binocular tube

$$\begin{aligned}
 \text{MTOT VIS} &= \text{MO} \times \text{ME} \times z \times q \times r \\
 &\text{or} \\
 &1 \times 25 \times 4 \times 1.5 \times 1.25 = 187.5\times
 \end{aligned}$$

Calculation example: field of view diameter in the specimen

$$\varnothing \text{ OF: } \frac{N_{\text{FOV}}}{\text{MO} \times z \times q \times r}$$

Care, Maintenance, Contact Persons

We hope you enjoy using your high-performance microscope. Leica microscopes are renowned for their robustness and long service life. Observing the following care and cleaning tips will ensure that even after years and decades, your Leica microscope will continue to work as well as on the very first day.

Warranty benefits

The guarantee covers all faults in materials and manufacture. It does not, however, cover damage resulting from careless or improper handling.

Contact address

However, if your instrument should no longer function properly, contact your technician, your Leica representative or Leica Microsystems (Switzerland) AG, CH-9435 Heerbrugg.

E-mail contact:

stereo.service@leica-microsystems.com

Care

- Protect your microscope from moisture, fumes and acids and from alkaline, caustic and corrosive materials and keep chemicals away from the instruments.
- Plugs, optical systems and mechanical parts must not be disassembled or replaced, unless doing so is specifically permitted and described in this manual.
- Protect your microscope from oil and grease.
- Do not grease guide surfaces or mechanical parts.

Care, Maintenance, Contact Persons (Continued)

Protection from dirt

Dust and dirt will affect the quality of your results.

- Put a dust cover over the instrument when it will not be used for a long time.
- Use dust caps to protect tube openings, tubes without eyepieces, and eyepieces.
- Keep accessories in a dust-free place when not in use.

Cleaning polymer components

Some components are made of polymer or are polymer-coated. They are, therefore, pleasant and convenient to handle. The use of unsuitable cleaning agents and techniques can damage polymers,

Permitted measures

- Clean the microscope (or parts of it) using warm soapy water, then wipe using distilled water.
- For stubborn dirt, you can also use ethanol (industrial alcohol) or isopropanol. When doing so, follow the corresponding safety instructions.
- Remove dust with a pneumatic rubber bulb or with a soft brush.
- Clean objectives and eyepieces with special optic cleaning cloths and with pure alcohol.



Leica Microsystems (Schweiz) AG · Max-Schmidheiny-Strasse 201 · 9435 Heerbrugg, Switzerland
T +41 71 726 34 34 · F +41 71 726 34 44

www.leica-microsystems.com

CONNECT
WITH US!

